

KRAFTWERK

FAVORITE TOOLS SINCE 1979

Válido de 15/10/2018 a 15/04/2019

PROMO



2018 / 2019-1

POWER SELECTION

A melhor ferramenta a um preço imbatível!

WWW.TECNIVERCA.PT

O MAIS VENDIDO!!!



Art. 1095

Carro de ferramentas, 7 gavetas com interior EVA.

- Chaves combinadas de 6 a 22 mm
- Chaves de caixa 1/4" de 4 a 14 mm
- Chaves de caixa 1/2" de 10 a 32 mm



€ 655,00

~~€ 785,00~~



Art. 1907

Carro de ferramentas, 7 gavetas, vazio

- Fecho central e individual
- Indicação do conteúdo da gaveta
- Duas rodas fixas e duas giratórias
- Travão em duas rodas

	L1 / mm	L2 / mm	L3 / mm	kg
	682	458	1000	205
A	565	395	58	25
B	565	395	138	30



€ 321,00

~~€ 367,65~~



Art. 102.100.001

Carro de ferramenta B107 com 7 gavetas, 304 pçs.

- Com superfície de armazenamento robusta com tapete de borracha
- Gavetas com tranca individual e calhas de rolamentos
- Fecho central de todas as gavetas com fecho cilíndrico
- Ferramenta inseridas em 6 espumas especiais EVA de alta densidade
- Chaves de 5.5 - 24 mm
- Chaves de caixa 1/4" 4 - 14 mm
- Chaves de caixa 1/2" 14 - 32 mm
- Chaves de caixa 3/8" 10 - 24 mm



€ 998,00
~~€ 1.099,-~~

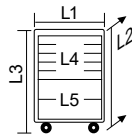

	L1	L2	L3	∅ kg
	682 mm	458 mm	1000 mm	205
L4	565 mm	395 mm	58 mm	25
L5	565 mm	395 mm	138 mm	30

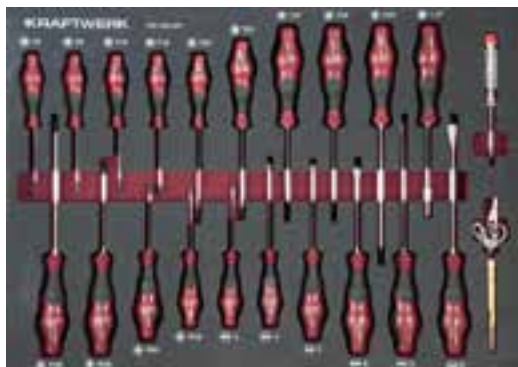

Art. 3934NG

Carro de ferramenta P407 com 7 gavetas

- Com protecção em aço inox
- Cantos protegidos em plástico endurecido
- 7 gavetas com tranca individual e calhas de rolamentos
- Fecho central de todas as gavetas com tranca de cilindro
- Abertura de gaveta simples (evita a abertura de várias gavetas em simultâneo)
- Possibilidade de armazenamento na parede lateral e na superfície de trabalho
- Incl. suporte de ferramenta p/ painel perfurado na lateral

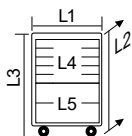

	L1	L2	L3	ΔΔ kg
	688 mm	482 mm	1013 mm	235
L4	531 mm	407 mm	65 mm	25
L5	531 mm	407 mm	145 mm	30



€ 685,00

~~€ 738,00~~

Art. 32008

GRÁTIS com Art. 102.230.515
Art. 102.400.515

Valor **€ 44,-**

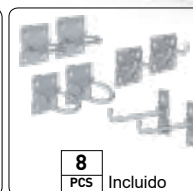
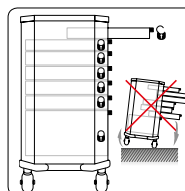

COMPLETO EVA3

Art. 105.515.000

Conjunto de ferramenta COMPLETO EVA

- Sortido generoso e bem seleccionado de 280 ferramentas profissionais
- Inseridas em 7 espumas especiais EVA de alta densidade
- Chaves de 5.5 - 32 mm
- Roquetes 1/4" + 3/8" + 1/2"
- Chaves de caixa 1/4" 3.5 - 14 mm
- Chaves de caixa 3/8" 8 - 24 mm
- Chaves de caixa 1/2" 10 - 32 mm
- Chave dinamométrica 1/2" 40 - 200Nm / 30 - 150 Lb.ft



Art. 102.230.515

(Art. 2907NG + 105.515.000)

€ 1690,00

~~€ 2050,00~~

Art. 102.400.515

(Art. 3934NG + 105.515.000)

€ 1830,00

~~€ 2270,00~~



Art. 2907NG

Carro de ferramentas, 7 gavetas, vazio (anti-queda)

- Gavetas de calhas com rolamentos completamente removíveis
- Bloqueio individual de cada gaveta
- Fecho centralizado
- Indicação do conteúdo da gaveta
- Topo em ABS com bandejas de armazenamento
- Rodas de rolamentos, duas fixas e duas rotativas
- Travão em duas rodas

	L1 / mm	L2 / mm	L3 / mm	kg
	695	475	885	240
Top	533	408	25	50
A	536	410	45	25
B	536	410	60	30
C	536	410	172	30



€ 525,00
~~€ 738,00~~



Art. 1906

Carro de ferramentas, 6 gavetas, vazio

- Fecho centralizado
- Duas rodas fixas e duas rodas giratórias
- Travão em duas rodas

	L1 / mm	L2 / mm	L3 / mm	kg
	678	405	925	150
A	570	370	56	20
B	570	370	81	20
C	570	370	106	20
D	570	370	155	20

€ 229,00
~~€ 275,00~~

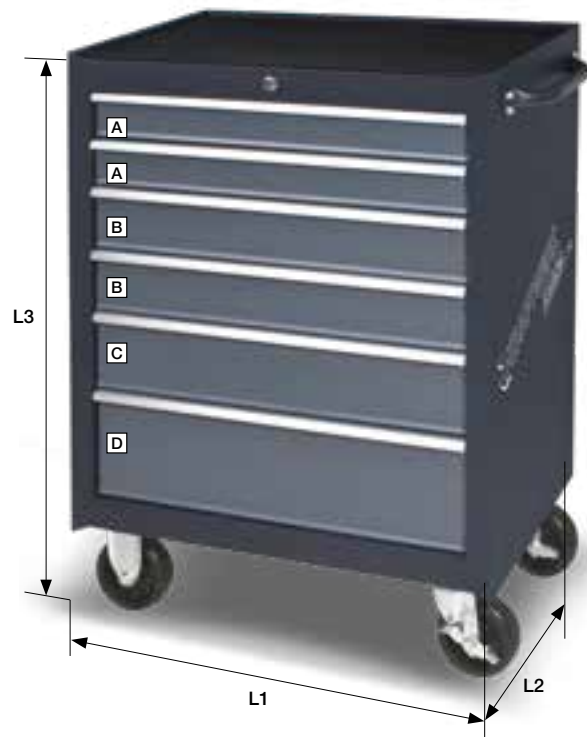

O MAIS VENDIDO!!!

Art. 3964D

Móvel de oficina de 4 elementos com carro e bancada em madeira multicamadas.

Fabricado na Alemanha

€ 2528,00

~~€ 2648,00~~

Art. 3964DIX

Móvel de oficina de 4 elementos com carro e bancada em INOX

€ 2615,00

~~€ 2728,00~~



+ 2955 x 458 X 2000 mm



+ 3920 x 458 X 2000 mm

Art. 3964F

Móvel de oficina de 6 elementos com bancada em madeira multicamada fabricado na Alemanha

€ 3398,00

~~€ 3558,00~~

Art. 3964FIX

Móvel de oficina de 6 elementos com bancada em INOX

€ 3485,00

~~€ 3648,00~~

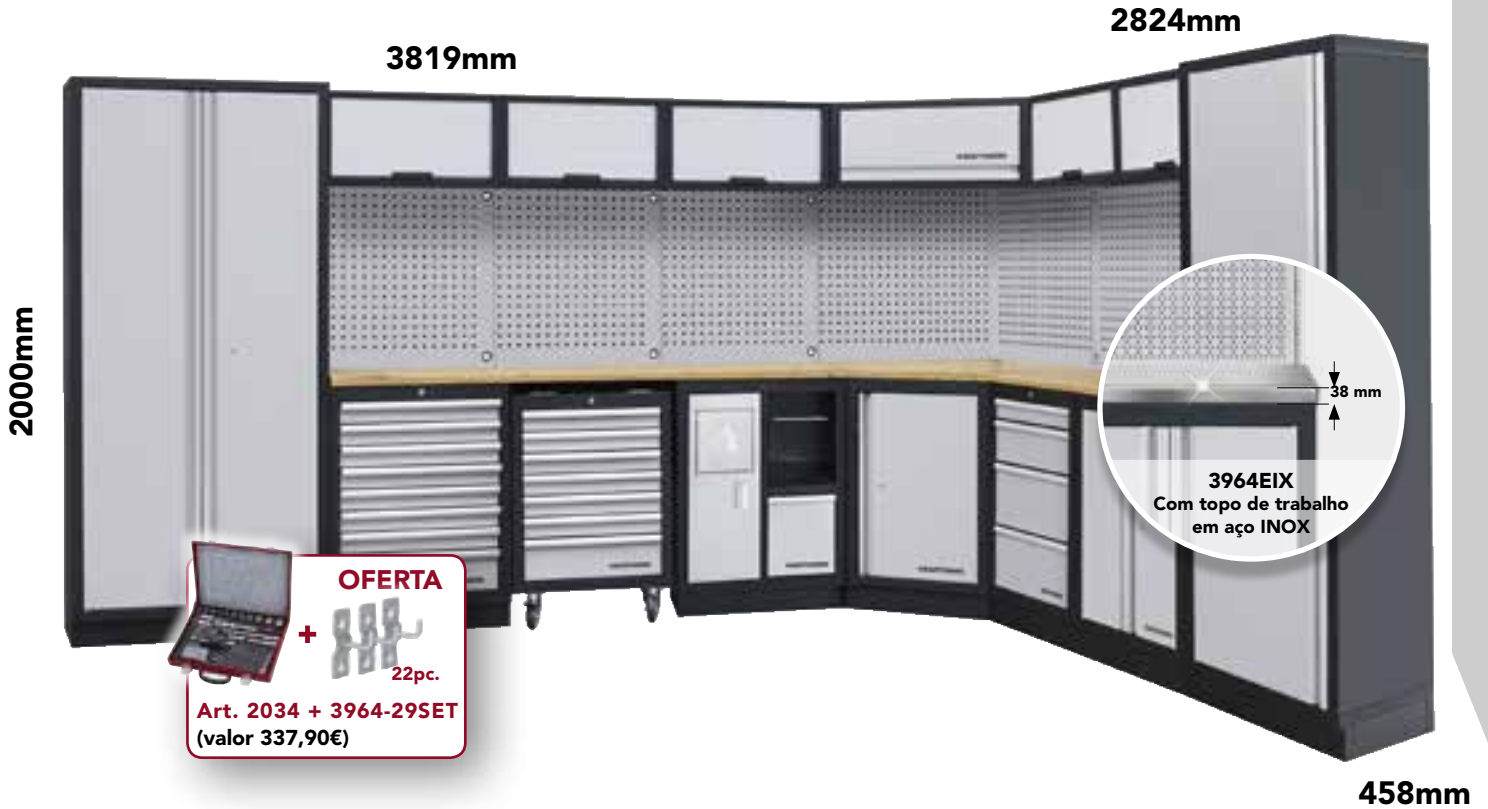

Art. 3964E

Móvel de oficina angular de 8 elementos com bancada em madeira multicamada fabricada na Alemanha

€ 4545,00

~~€ 5248,00~~

Art. 3964EIX

Móvel de oficina angular de 8 elementos com bancada em INOX

€ 4680,00

~~€ 5388,00~~



Art. 3964-28-99
Com topo em madeira



Art. 3964-28-98
Com topo em INOX



Art. 31032
Pistola de soprar



Art. 31041
Enrolador automático



+ 680 x 680 x 300mm

Armário para enrolador com duas gavetas

Art.	Descrição	Promo €	PVP €
3964-28	Armário base	355,00	420,00
3964-28-99	Armário base com tampo de madeira	384,00	468,00
3964-28-98	Armário base com tampo de INOX	403,00	495,00
3964-28-97	Armário base com tampo de madeira + 31041 + 31032	469,00	568,00
3964-28-96	Armário base com tampo de INOX + 31041 + 31032	498,00	595,00

Art. 3964-27

Armário suspenso com duas portas (prateleira incluída)

€ 169,00

~~€ 199,80~~

ACESSÓRIOS PARA MOBILIO

ACESSÓRIOS MOBILIO

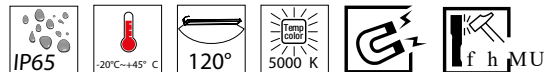

SMD-LED	LM	W	Kg
120	1800	20	1.2

SMD-LED	LM	W	Kg
240	3600	40	2.3

Art. 32077-60

Iluminação LED 60 cm

€ 88,50

~~€ 96,00~~

Art. 32077-120

Iluminação LED 120 cm

€ 139,50

~~€ 148,00~~



Art. 3964-29-01

Suporte para latas

€ 16,90

~~€ 19,90~~



Art. 3964-29-11

Suporte para caixas plásticas

€ 3,55

~~€ 4,20~~



Caixas plásticas azuis

Art.	Descrição	Promo €	PVP €
3964-29-14	105x75x140 mm	4,40	5,20
3964-29-15	140x125x220 mm	10,40	12,30
3964-29-16	140x125x270 mm	11,70	13,90



Gancho para mobiliário

Art.	Descrição	Promo €	PVP €
3964-29-02	Gancho 35 mm	1,00	1,20
3964-29-03	Gancho 87 mm	1,19	1,40
3964-29-04	Gancho 150 mm	1,60	1,90



Gancho duplo para mobiliário

Art.	Descrição	Promo €	PVP €
3964-29-05	Gancho duplo 35 mm	1,35	1,60
3964-29-06	Gancho duplo 87 mm	1,60	1,90
3964-29-07	Gancho duplo 150 mm	2,20	2,60

Art. 3964-29-08 Suporte de alicates para mobiliário

€1,75

~~€2,10~~



+ 60 x 58 x 40.5 mm

+ 370 x 48 x 33.5 mm



Art. 3964-29-09

Suporte de martelo para mobiliário

€1,85

~~€2,20~~



+ 60 x 58 x 58 mm

Art. 3964-29-10

Suporte para 12 chaves para mobiliário

€7,80

~~€9,20~~



+ 142 x 176 x 41 mm

Art. 3964-29-12

Suporte para 8 chaves para mobiliário

€6,60

~~€7,80~~

Art. 3964-29-13

Suporte para 10 brocas para mobiliário

+ 112 x 91 x 25 mm



€3,75

~~€4,40~~

Art. 3964-29SET

Kit de suportes de mobiliário, 22pcs

€ 34,00

~~€ 39,90~~



COMPLETO SERIE 4900



COMPLETO EVA SERIE 4902



COMPLETO EVA3 SERIE 4903



Art. 3949



489 x 365 x 178 mm



1/4" 1/2" 1/4" 4 mm CrV 264 PCS

1/4" 1/2" 1/4" 3.5-14 mm
1/2" 1 32 mm
5-

1/4"

4 mm

8- mm

19



ALUPRO

Malas de alumínio com ferramentas profissionais

- Protecção contra impacto lateral
- Bandejas anti transbordamento (material em espuma EVA e superfície laminada)
- Bolsos especiais com elástico

**QUALIDADE
PROFISSIONAL!!!**



€ 550,00

€ 688,00

Navegue em segurança com a mala náutica KRAFTWERK.

HERMÉTICA!



inox

100
PCS

IP67

Art. 3993

Mala Náutica 100 peças

↕ 430 x 380 x 154 mm
peso: 11,9 Kg

Descrição:

- Fechadura hermética
- Resistente à água e poeira
- Prática e robusta
- 4 bandejas EVA de superfície laminada em carbono



€ 345,00

~~€ 495,00~~



Electricidade de alta voltagem torna-se fácil com a mala 4057 KRAFTWERK.



1000VOLTS!

↕ 555 x 345 x 215 mm
peso: 12,4 Kg

Art. 4057

Mala trolley com sortido universal de ferramentas 1000V, 65 peças

- Mala sobre rodas
- Fechadura hermética
- Alça de transporte telescópica



€ 597,00

~~€ 658,00~~

S2
quality

CrV





65
PCS





↕ 489 x 193 x 400 mm





Art. 3995

**Mala de ferramentas profissionais em ABS
1/4" + 3/8"**

- 

3.5-4-4.5-5-5.5-6-7-8-9
10-11-12-13-14 mm
- 

10-13-14-15-16-17-18
19-20-21-22-24 mm



€ 455,00

~~€ 548,00~~

O MAIS VENDIDO!!!







↕ 485 x 260 x 240 mm

**TODA A FERRAMENTA
ORGANIZADA**

Art. 3036

Mala universal com 5 compartimentos

- 

3.5-4-5-6-7-8-9
10-11-12-13 mm
- 

10-13-14-15-16-17-18
19-21-22-24-27-30-32 mm





€ 189,00

~~€ 225,00~~





Equipada com ferramenta









↕ 380 x 302 x 85 mm

Art. 1042

Mala de ferramenta universal, 100 peças

- 

4-4.5-5-5.5-6-7-8-9 mm
- 

10-11-12-13
14-15-17-18-19 mm

€ 99,00

~~€ 125,00~~

Art. 1048

Mala de ferramentas universais, 88 peças



6-7-8-9-10-11-12-13-14-15
16-17-18-19-21-22-24 mm

410 x 353 x 93 mm



€ 111,00

€ 139,80

Art. 1052

Mala de ferramentas universais e aparafusadora a bateria 7.2V, 163 peças

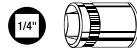

8 4-4.5-5-5.5-6 mm



11 7-8-9 - 10-11-12-13-14
15-16-17-18-19 mm

Com almofada de apoio para cabeça ou joelhos



163
PCS



€ 158,00

€ 188,00



Art. 1049

Mala de ferramentas universais, 243 peças



4-4.5-5-5.5-6-7-8-9
10-11-12-13 mm



10-11-12-13-14-15-16
17-18-19-20-21-22-24
27-30-32 mm



492 x 440 x 188 mm



€ 265,00

€ 342,00



533 x 340 x 219 mm

Art. 1046

Baú de ferramenta com ferramentas universais, 100 pcs

- Estrutura robusta com grande compartimento e 4 gavetas totalmente removíveis
- Fecho centralizado



4-5-6-7-8-9-10
11-12-13-14 mm

10-13-15-16-17
18-19-20-21-22
24-27-30-32 mm



COM CHAVES DE ROQUETE!!!



100
PCS

€ 310,00

~~€ 368,00~~



Art. 1046-107

Aparafusadora a bateria 10.8V para utilizar em bandeja no baú 1046.

€ 105,00

~~€ 141,75~~

Art. 1046E

Baú transportável vazio

4 GAVETAS!

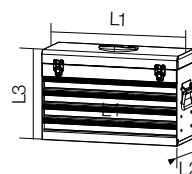

	L1 mm	L2 mm	L3 mm
	533	219	340
L4	502	187	42



€ 95,00

~~€ 112,95~~



↕ 451 x 331 x 150 mm

Art. 1994

Mala de ferramentas vazia

- Estrutura de aluminio reforçada
- Estrutura em aluminio
- Divisórias internas ajustáveis
- Cabo emborrachado
- Protecção lateral à prova de choque
- Compartimentos para ferramentas



€ 42,00

~~€ 49,80~~



↕ 486 x 373 x 190 mm exterior

Art. 2998

Mala de ferramentas vazia

- Estrutura em ABS
- Estrutura de aluminio sólida reforçada
- Protecção lateral anti-choque
- Fechadura de combinação



ABS

€ 107,00

~~€ 128,00~~



↕ 490 x 410 x 265 mm exterior

Art. 2995

Mala de ferramentas profissional com trolley

- Estrutura em ABS
- Estrutura de aluminio sólida reforçada
- Protecção lateral anti-choque
- Fechadura de combinação
- Rodas em borracha



max.
66 cm



ABS

€ 142,00

~~€ 169,50~~

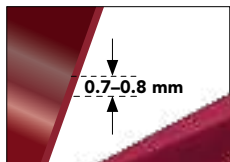

**ROBUSTA CONSTRUÇÃO
EM AÇO. FABRICO
EUROPEU!**

Art. 3952

Caixa de ferramenta metálica,
5 compartimentos

€ 32,90

~~€ 39,05~~

Art.	↕	⇄
3952	430 x 200 x 200 mm	5.8 kg
3950	530 x 200 x 200 mm	6.5 kg

Art. 3950

Caixa de ferramenta metálica,
5 compartimentos

€ 35,90

~~€ 43,15~~

Art. 3953

Caixa de ferramenta em aço inoxidável

inox



Art.	↕
3953	400 x 230 x 200 mm
3954	420 x 250 x 200 mm

€ 24,00

~~€ 29,00~~

Art. 3953

€ 32,00

~~€ 39,00~~

Art. 3954

Art. 2904

Baú de ferramenta vazio Racing
- 3 gavetas em guias de rolamentos
- Trancas individuais
- Fecho centralizado



↕ 695 x 475 x 345 mm



Compatível com 2905 e 2907

€ 287,00

~~€ 342,00~~

Mala de ferramentas em tecido técnico.

Construção robusta em 600 Deniers |
Reforços laterais | Cobertura com fecho |
Numerosos bolsos internos | Fundo em PVC
sólido | Alça de ombro acolchoada

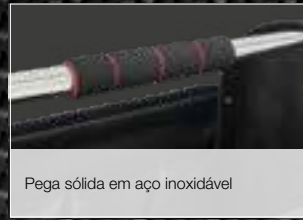

Mala em tecido técnico.

Art.	↕	max. ⚖️	L
3955	400 x 220 x 350 mm	15 kg	24
3956	510 x 360 x 400 mm	20 kg	42

Art. 3955

€ 24,90

~~€ 29,50~~

Art. 3956

€ 32,00

~~€ 38,00~~

Mochila de ferramentas com Trolley, 20L

Art.	↕	max. ⚖️	L
3957	350 x 200 x 550 mm	20 kg	20

Art. 3957

€ 82,00

~~€ 98,00~~



Art.	↕	max. ⚖️	L
3958	390 x 210 x 300 mm	18 kg	10

€ 41,00

~~€ 49,50~~

Art. 3958

Mala de ferramentas
com pega em aço
inoxidável, 10L



Art.	↕	max. ⚖️	L
3959	440 x 260 x 370 mm	23 kg	40

€ 67,00

~~€ 79,50~~

Art. 3959

Mala de ferramentas com
pega em aço inoxidável, 40L



**SACO DISPONIVEL
COM SORTIDO DE
30 FERRAMENTAS**



Art.	Descrição	Dimensões	Peso Max	Promo €	PVP €
3955-30	Mala de ferramentas, 24L completa com 30 peças	400 x 220 x 350 mm	15Kg	121,00	170,00
3956-30	Mala de ferramentas, 42L completa com 30 peças	510 x 360 x 400 mm	20Kg	129,00	178,50
3957-30	Mala de ferramentas com Trolley, 20L completa com 30 peças	350 x 200 x 550 mm	20Kg	178,00	238,50
3958-30	Mala de ferramentas com pega em aço inox, 10L completa com 30 peças	390 x 210 x 300 mm	18Kg	142,00	190,00
3959-30	Mala de ferramentas com pega em aço inox, 40L completa com 30 peças	440 x 260 x 370 mm	23Kg	164,00	220,00

Art. 3996ET

Conjunto de electricista

- Composto por ferramentas isoladas 1000V
- Bolsa de cintura robusta e espaçosa
- Dimensões 220x300x100 mm



↕ 220 x 300 x 100 mm

€ 118,00

20
PCS

~~€ 168,00~~

Art. 1008

Sortido de chaves de caixa e bits 1/4" em caixa, 88 peças



















↕ 250 x 150 x 51 mm

88
PCS

€ 31,00

~~€ 38,80~~

- 13   4-4.5-5-5.5-6-7-8-9
10-11-12-13-14 mm
-  1/4"  1/4"
- Art. 1000
- 6  4-4.5-5.5-6-6.5-8 mm
- 5  PH 0-1-2-3-4
- 4  PZ 1-2-3-4
- 15  T8-T10-2xT15-3xT20-3xT25
T27-2xT30-2xT40
- 8  T8-T10-T15-T20-T25-T27-T30-T40
- 6  3-4-5-6-7-8 mm
- 5  2-3-4-5-6 mm
- 3  No. 6-8-10
- 4  No. 1-2-3-4
- 4  No. 4-6-8-10
-  1/4"  1/4"

Art. 2004

Sortido de chaves de caixa 1/4" em caixa metálica, 62 peças











€ 59,50

~~€ 69,50~~

↕ 288 x 137 x 48 mm

62
PCS

- 14   3.5-4-4.5-5-5.5-6-7-8
9-10-11-12-13-14 mm
- 5  5.5-7-8-10-13 mm
- Art. 3200 
- 3  4-5-5-6.5 mm
- 3  PH 1-2-3
- 3  PZ 1-2-3
- 8  T8-T10-T15-T20-T25-T27-T30-T40
- 6  3-4-5-6-7-8 mm

Art. 4017

Conjunto de chaves HIGHTECH 3/8" com roquete, 101 peças









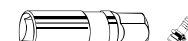

↕ 400 x 290 x 80 mm

101
PCS

€ 168,00

~~€ 248,00~~

-   6-7-8-9-10-11-12-13-14-15
16-17-18-19-20-21-22-24 mm
-  10-11-12-13-14-15-17-18-19-22 mm
-  14-16-18-21 mm
- Art. 4011
- 5/16"   5.5-6.5-8-10-12 mm
-  PH 1-2-3-4
-  PZ 1-2-3-4
-  T10-T15-T20-T25-T27-T30
T40-T45-T50-T55-T60-T70
-  M5-M6-M8-M10-M12



↕ 295 x 215 x 75 mm

Art. 1022

Sortido de chaves de caixa 1/2", 22 peças



10-11-12-13-14-15-16-17-18
19-22-24-27-30-32 mm



16 mm / 21 mm

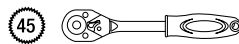

Art. 1020

€ 67,00

~~€ 89,15~~



↕ 400 x 290 x 80 mm

Art. 4027

Chaves de caixa HIGHTECH 1/2", 42 peças



8-34 mm



E10-E24



10-22 mm

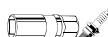

14-16-18-21 mm



42
PCS

€ 129,00

~~€ 198,00~~

**COM ROQUETE DE
120 DENTES FINOS**



↕ 260 x 160 x 60 mm

Art. 4013

**Mala de ferramenta HIGHTECH
1/4"+ 3/8", 48 peças**



12 E4-E5-E6-E7-E8-E10-E11
E12-E14-E16-E18-E20



12 T8-T10-T15-T20-T25-T27
T30-T40-T45-T50-T55-T60



7 T10-T15-T20-T25-T27-T30-T40

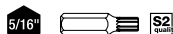

4 T45-T50-T55-T60

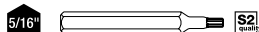

5 M5-M6-M8-M10-M12

48
PCS

€ 55,00

~~€ 78,00~~

O MAIS VENDIDO!!!

Art. 1037

Mala de ferramentas com roquetes 1/4" + 3/8" + 1/2", 200 peças

- Em caixa plástica
- Chaves de caixa 1/4" de 4 a 14 mm
- Chaves de caixa 3/8" da 10 a 19 mm
- Chaves de caixa 1/2" da 10 a 32 mm

COM SISTEMA SUPER-LOCK



200
PCS

€ 108,00

~~€ 128,00~~

↕ 445 x 330 x 90 mm

Peso: 9 Kg

COM ROQUETES EXTENSIVEIS



81
PCS

↕ 435 x 350 x 69 mm

Art. 2034

Mala de chaves de caixa universal COMBI 1/4" + 1/2", 81 pças

€ 195,00

~~€ 298,00~~



	13	<p>1/4" 4-14 mm 3/8" 10-19 mm 1/2" 10-32 mm</p>		<p>150 mm 180 mm</p>
	12	<p>1/4" 4-14 mm 1/2" 10-32 mm</p>		<p>150 mm 180 mm</p>



↔ 550 x 380 x 110 mm

Art. 4037

Conjunto de chaves de caixa 1/4" + 1/2", 133 pçs

- 1/4" 3.5-4-4.5-5-5.5-6-7-8
9-10-11-12-13-14 mm
- 4-4.5-5-5.5-6-7-8
9-10-11-12-13 mm
-
- 120 Art. 4001
- 1/2" 10-13-14-15-16-17-18-19
20-21-22-24-27-30-32-34 mm
- 15-17-19-21-22 mm
- 120 Art. 4021

**COM ROQUETE FINE
POWER 120 DENTES**

133
PCS

€ 229,00

~~€ 348,00~~

Art. 2032

Conjunto de chaves de caixa 1/4" + 1/2" em mala metálica, 72 peças

- 1/4" 3.5-4-4.5-5-5.5-6-7-8-9
10-11-12-13 mm
- 45 Art. 3200
-
- 1/4" T10-T15-T20-T25-T27-T30-T40
- 1/2" 14-15-16-17-18-19-21
22-24-27-30-32 mm
- 45 Art. 3220



↔ 450 x 190 x 57 mm

€ 109,00

~~€ 128,00~~

1/4"

1/2"

1/4"

CrV

S2
quality

72
PCS

Art. 2057

Conjunto de chaves de caixa com roquete extensível 3/4", 21 peças

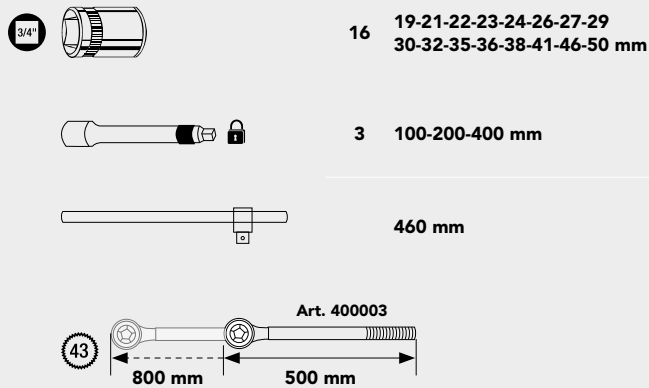

€ 269,00

~~€ 408,00~~

ROQUETE EXTENSIVEL 3/4" ATÉ 800 MM



↕ 535 x 383 x 100 mm

Art. 2053

Conjunto de chaves de caixa de 1" em caixa metálica, 21 peças

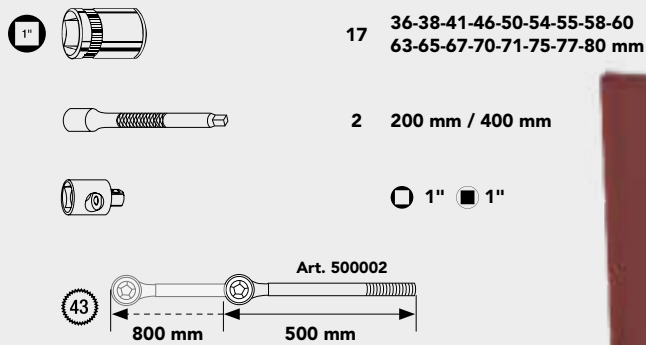

€ 569,00

~~€ 905,00~~

ROQUETE EXTENSIVEL 1" ATE 800 MM



↕ 700 x 280 x 108 mm

O MAIS VENDIDO!!!

FINE POWER: ROBUSTEZ E PRECISÃO GRAÇAS A ENGRENAGEM DÚPLA DE 60 DENTES



Roquete de alta precisão com dentes finos HIGHTECH FINE POWER



Art.	Descrição	Promo €	PVP €
4001	1/4"	21,50	29,80
4011	3/8"	28,50	39,80
4021	1/2"	36,00	49,80

Art. 3235RK1

Jogo de chave dinamometrica 1/2", 11 peças
- Com chaves de 13 a 30mm
- Cabeça reversível - Industrial



€ 191,00

~~€ 306,05~~

↕ 620 x 169 x 65 mm

1/2"



Roquete reversível



Art.	Descrição	Promo €	PVP €
3200	1/4"	17,90	28,50
3210	3/8"	20,90	33,30
3220	1/2"	25,90	39,90

Art. 3235GK1

Jogo de chave dinamometrica 1/2", 11 peças
- Com chaves de 13 a 30mm
- Cabeça reversível - Industrial

€ 187,00

~~€ 298,80~~



↕ 620 x 169 x 65 mm

1/2"

O MAIS VENDIDO!!!



Chave dinamometrica

- Janela de leitura para valores em Nm e Lb.in.
- Movimento reversível de 45 dentes.
- Estrutura robusta
- Cabo ergonómico em bi-matéria com bloqueio ajustável

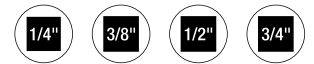

Art.	Descrição	Promo €	PVP €
3231	1/4" 2.5-12 Nm	78,00	100,65
3232	1/4" 4-20 Nm	78,00	99,00
3233	3/8" 10-60 Nm	88,00	111,00
3234	3/8" 25-125 Nm	88,00	114,00
3235	1/2" 40-200 Nm	98,00	128,00
3236	1/2" 65-335 Nm	108,00	139,50
3237	3/4" 160-800 Nm	488,00	658,00

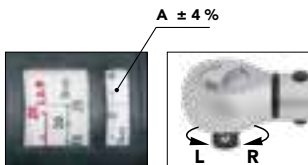

TRANSFORME UM ROQUETE NUMA CHAVE DINAMOMÉTRICA!

Medidor de binário electrónico e dinamometro electrónico.

- Calibração automática a zero ao ligar
- Indicação do binário ou configuração, através de aviso visual e sonoro ao atingir ou ultrapassar o valor definido
- Modo de leitura/pico: indica a evolução da força aplicada até que o binário desejado seja atingido
- Precisão de medição: tolerância $\pm 2\%$
- 50 memorias
- Bateria e certificado de teste DIN EN ISO 6789 incluido.

Art.	Descrição	Promo €	PVP €
4081-14	Adaptador 1/4" dinamometrico digital 6-30 Nm	59,50	90,40
4081-38	Adaptador 3/8" dinamometrico digital 27-135 Nm	59,50	90,40
4081-12	Adaptador 1/2" dinamometrico digital 40-200 Nm	59,50	90,40
4081-34	Adaptador 3/4" dinamometrico digital 100-500Nm	116,00	182,80
4081-341	Adaptador 3/4" dinamometrico digital 200-1000Nm	122,90	193,10



135 mm

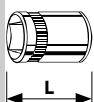

7 E4-E5-E6-E7-E8-E10-E11



265 mm

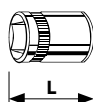

12 E4-E5-E6-E7-E8-E10-E11
E12-E14-E16-E18-E20

Art. 120099

Serie MAGALU chaves de caixa 1/4" Torx

€ 17,90



~~€ 27,20~~



7
PCS

Art. 220099

Serie MAGALU chaves de caixa 3/8" Torx

€ 36,90



~~€ 54,95~~



12
PCS



240 mm

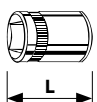

8 E10-E12-E14-E16-E18-E20-E22-E24



265 mm

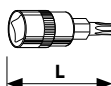

1/4" 7 T8-T10-T15-T20-T25-T27-T30
1/2" 6 T40-T45-T50-T55-T60-T70

Art. 320099

Serie MAGALU chaves de caixa 1/2" Torx

€ 36,90



~~€ 54,95~~



8
PCS

Art. 99045

Serie MAGALU chaves de caixa 1/4" e 1/2" bits Torx

€ 47,90



13
PCS



S2
quality

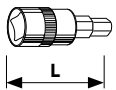

6 ● 3-4-5-6-7-8 mm

Art. 106099

Serie MAGALU chaves de caixa 1/4" bits sextavado

€ 18,90

~~€ 30,60~~

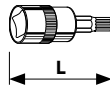
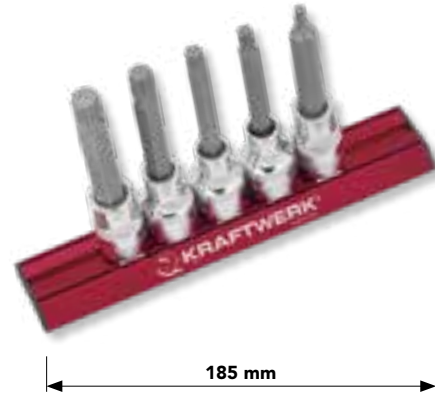

7 ● M5-M6-M8-M10-M12-M14-M16

Art. 328099

Serie MAGALU chaves de caixa 1/2" bits XZN

€ 36,90

~~€ 58,05~~

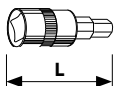
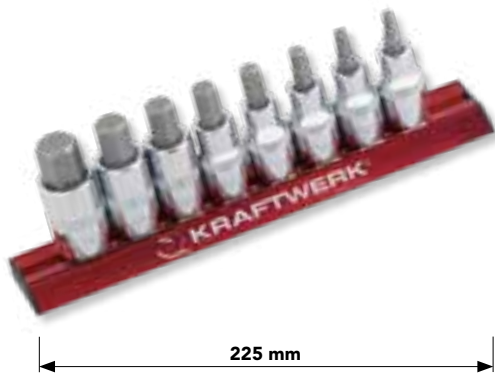

8 ● 5-6-7-8-10-12-14-17 mm

Art. 326099

Serie MAGALU chaves de caixa 1/2" bits sextavado

€ 42,50

~~€ 69,30~~

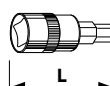

1/4" 5 ● 3-4-5-6-7 mm
1/2" 5 ● 8-10-12-14-17 mm

Art. 99046

Serie MAGALU chaves de caixa 1/4" e 1/2" bits sextavado

€ 41,90

~~€ 61,10~~



UMA CHAVE, VÁRIOS TIPOS DE PARAFUSOS POLEGADA, TORX, SPLINE, XZN E QUADRADO



Art. 3501-57R

Conjunto de chaves combinadas COMBI
5,5-22 mm, 18 peças



18
PCS

€ 72,90

~~€ 106,00~~



Art. 3501-58R

Conjunto de chaves combinadas COMBI
24-32 mm, 4 peças



4
PCS

€ 61,00

~~€ 97,00~~

Art. 130001

Roleta universal COMBI 1/4"

↕ 30 mm / Ø 62 mm

mm	inch	TX	XZN
8-10-11-13	5/16"-3/8" 7/16"	E10-E12	M8-M10
14-16-17 mm	1/2"-9/16"-5/8"-11/16"	E14-E18	M12-M14 M16-M18

€ 9,99

~~€ 15,95~~



Art. 3401-50

Jogo de chaves boca-luneta com roquete duplo, direitas, 4 peças
 - 10, 13, 17 e 19mm
 - com mecanismo de roquete adicional na boca

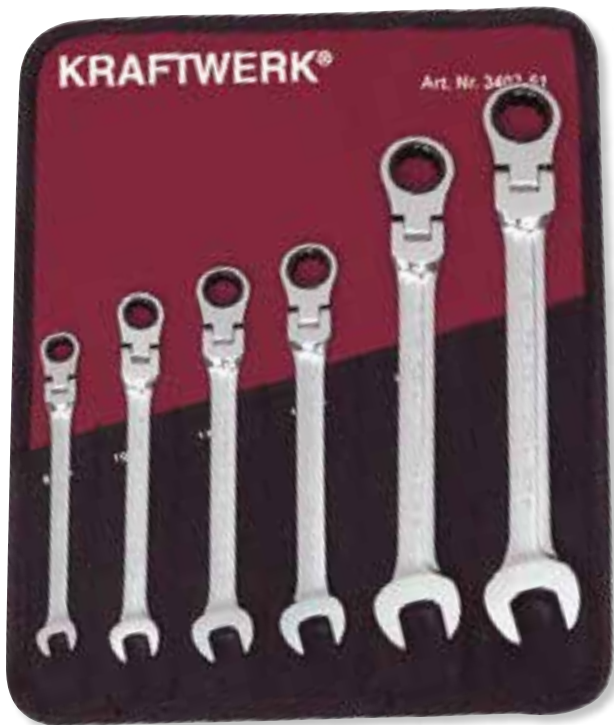
€ 47,00**4**
PCS~~€ 61,10~~**CHAVES COM ROQUETE ARTICULADO****Art. 3403-51**

Jogo de chaves boca-luneta com roquete CLICKRAFT 8-19 mm, 6 peças
 - Ângulo até 180°
 - 8-10-12-13-17-19mm

€ 78,00**6**
PCS~~€ 114,00~~**Art. 3404-54**

Jogo de chaves boca-luneta com roquete CLICKRAFT 8-19 mm, 12 peças
 - 8-9-10-11-12-13-14-15-16-17-18-19mm

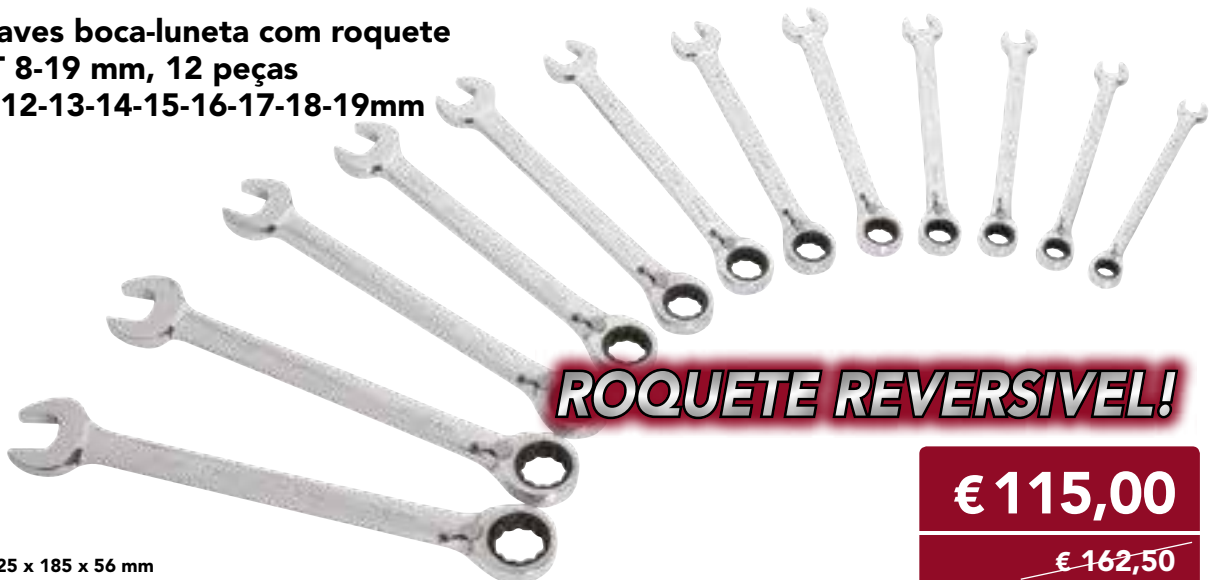

325 x 185 x 56 mm

€ 115,00~~€ 162,50~~

Art. 3404-1019

Chave reversível CLICKRAFT 4 em 1
10 - 13 - 17 - 19 mm

€ 20,50

4 EM 1

~~€ 30,30~~



Art.	Ø	L mm	Ø
3404-1019	10 x 13 mm 17 x 19 mm	200	72 x 75

Art. 3558R

Jogo de chaves boca-luneta 24-32 mm, 4 peças

€ 45,00

~~€ 67,80~~



Ø mm
24-27-30-32

↕ 485 x 295 mm

4
PCS

Em bolsa

Art. 3554R

Jogo universal de chaves boca-luneta,
26 peças

- Polidas

- Com bolsa de transporte

€ 39,50

~~€ 59,55~~

Ø mm
5.5-6-7-8-9-10-11-12-13-14-15-16-17-18-19-20-21-22-23-24-25-26-27-28-30-32

5.5-6-7-8-9-10-11-12-13-14-15-16-17-18-19-20-21-22-23-24-25-26-27-28-30-32

Art. 3557R

HIGHTECH

Jogo de chaves boca-luneta 5.5-22 mm
18 peças

18
PCS

↕ 540 x 420 mm



€ 59,50

~~€ 89,00~~

Ø mm
5.5-6-7-8-9-10-11-12-13-14-15-16-17-18-19-20-21-22

Art. 3553R

Jogo de chaves de bocas 6-32mm, 10 peças



Ø mm
6x7-8x9-10x11-12x13-14x15-16x17-18x19-21x22-24x27-30x32

€ 45,00

~~€ 71,40~~

10
PCS

CrV



Art. 3577

Chave ajustável com mecanismo de roquete
ErgoKraft

- Comprimento 210 mm / abertura 0 - 26 mm
- Alavanca de manobra de roquete

€ 33,00

~~€ 54,95~~



MECANISMO DE ROQUETE

Art. 4160

Conjunto de chaves de parafusos
ErgoKraft Fenda/Phillips, 7 peças

	Art. 4110-1	0.6 x 3 mm	
	Art. 4110-2	0.8 x 4 mm	
	Art. 4110-3	1.0 x 5 mm	
	Art. 4110-4	1.1 x 6 mm	
	Art. 4110-5	1.2 x 8 mm	
	Art. 4115-1	PH 1	
	Art. 4115-2	PH 2	



€ 18,20

~~€ 29,80~~



- ★ Art. 4125-08 T8
- Art. 4125-10 T10
- Art. 4125-15 T15
- Art. 4125-20 T20
- Art. 4125-25 T25
- Art. 4125-27 T27
- Art. 4125-30 T30
- Art. 4125-40 T40



S2 quality **8 PCS**



- ★ Art. 4126-08 T8
- Art. 4126-10 T10
- Art. 4126-15 T15
- Art. 4126-20 T20
- Art. 4126-25 T25
- Art. 4126-27 T27
- Art. 4126-30 T30
- Art. 4126-40 T40



S2 quality **8 PCS**

Art. 4165

Conjunto de chaves de parafusos
ErgoKraft Torx, 8 peças



€ 23,50

~~€ 36,75~~

Art. 4166

Conjunto de chaves de parafusos
ErgoKraft TX e segurança, 8 peças



€ 24,50

~~€ 37,80~~

KIT COMPLETO



380 x 250 x 72mm



S2 quality

24 PCS



- Art. 4110-1 0.6 x 3 mm
- Art. 4110-2 0.8 x 4 mm
- Art. 4110-3 1.0 x 5 mm
- Art. 4110-4 1.1 x 6 mm
- Art. 4110-5 1.2 x 8 mm
- Art. 4110-6 1.6 x 10 mm



- Art. 4112-2 1.1 x 6 mm



- Art. 4115-0 PH 0
- Art. 4115-1 PH 1
- Art. 4115-2 PH 2
- Art. 4115-3 PH 3



- Art. 4117-2 PH 2



- Art. 4120-0 PZ 0
- Art. 4120-1 PZ 1
- Art. 4120-2 PZ 2
- Art. 4120-3 PZ 3



- Art. 4128 1/4"



- Art. 4128 1/4"



- Art. 4128 1/4"



- ★ T10-T15-T20-T25-T27-T30-T40

Art. 4168

Conjunto universal de chaves de parafusos
ErgoKraft, 24 peças

€ 44,50

~~€ 69,55~~

ISOLADAS 1000V



- 

Art. 3132-1	2.5 x 75 mm
Art. 3132-4	4.0 x 100 mm
Art. 3132-5	5.5 x 125 mm
Art. 3132-6	6.5 x 150 mm
- 

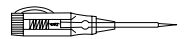
Art. 3135-0	PH 0 x 60 mm
Art. 3135-1	PH 1 x 80 mm
Art. 3135-2	PH 2 x 100 mm
- 

Art. 2138	100-250 V
-----------	-----------



Art. 3157

Conjunto de chaves de parafusos isoladas 1000V Fenda + Phillips, 8 peças

€26,00

~~€ 37,80~~



- 

Art. 3177-20	0.45 x 2.0 mm
Art. 3177-24	0.50 x 2.4 mm
Art. 3177-30	0.60 x 3.0 mm
Art. 3177-35	0.65 x 3.5 mm
Art. 3177-40	0.80 x 4.0 mm
- 

Art. 3177-00	PH 00
Art. 3177-0	PH 0
Art. 3177-1	PH 1



Art. 3177

Conjunto de chaves de parafusos de precisão, Fenda+Phillips, 8 peças

€17,50

~~€ 27,20~~



- 

Art. 3178-05	T 5
Art. 3178-06	T 6
Art. 3178-07	T 7
Art. 3178-08	T 8
- 

Art. 3179-09	T 9
Art. 3179-10	T 10
Art. 3179-15	T 15
Art. 3179-20	T 20



Art. 3178

Conjunto de chaves de parafusos de precisão Torx+ Torx Tamper, 8 peças

€17,50

~~€ 27,20~~

**Art. 3601**

Conjunto de chaves em L sextavadas interiores 1.5-10 mm, 9 peças

mm

1.5-2-2.5-3-4-5-6-8-10

€5,90
9
PCS

DIN / ISO 2936

~~€ 8,95~~**Art. 3602**

Conjunto de chaves em L sextavadas interiores com ponta esférica 1.5-10 mm, 10 peças

mm

1.5-2-2.5-3-4-5-6-7-8-10

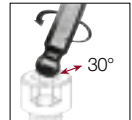
€ 12,50

DIN / ISO 2936

~~€ 18,50~~
S2
quality

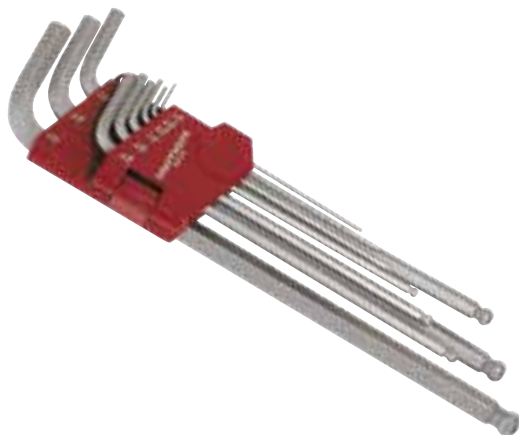
10
PCS
**Art. 3603**

Conjunto de chaves em L sextavada interior com ponta esférica polegada extra longa T10-T50, 9 peças

inch

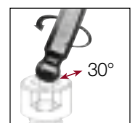
1/16"-5/64"-3/32"-1/8"-5/32"
3/16"-1/4"-5/16"-3/8"
€ 18,00

DIN / ISO 2936

~~€ 25,15~~
S2
quality

10
PCS
**Art. 3607**

Conjunto de chaves macho extra-longas Torx T10-T50, 9 peças

T10-T15-T20-T25-T27
T30-T40-T45-T50
€ 18,90
S2
quality

XXL
9
PCS
~~€ 27,00~~

O MAIS VENDIDO!!!

1/4" 1/4" 138 PCS

C6.3 E6.3

DIN 3126
ISO 1173



220 x 150 x 45 mm

€ 29,00

~~€ 38,90~~

Art. 2778

Mala de bits universal 1/4", 138 peças

1/4" 25 mm

1/4" 50 mm

- 6 4-4.5-5.5-6-6.5-8 mm
 - 6 2xPH1 - 2xPH2 - 2xPH3
 - 6 2xPZ1 - 2xPZ2 - 2xPZ3
 - 28 2xT8 - 2xT10 - 2xT15 - 5xT20 - 6xT25 - 3xT27 - 4xT30 - 4xT40
 - 16 2xT8 - 2xT10 - 2xT15 - 2xT20 - 2xT25 - 2xT27 - 2xT30 - 2xT40
 - 15 TS10 - 2xTS15 - 2xTS20 - 3xTS25 - 2xTS27 - 3xTS30 - 2xTS40
 - 5 3-4-5-6-8 mm
 - 3 3-4-5 mm
 - 3 Nos. 6-8-10
 - 3 Nos. 1-2-3
 - 4 Nos. 4-6-8-10
 - 2 Nos. 1-2
 - 3 M5-M6-M8
 - 4 Nos. 1-2-3-4
 - 3 4-5-5-6.5 mm
 - 3 PH 1-2-3
 - 3 PZ 1-2-3
 - 7 T10-T15-T20-T25-T27-T30-T40
 - 2 3-6 mm
- 1/4" 1/4" 1/4" Art. 2750

MARTELÁVEL: PARA PARAFUSOS BLOQUEADOS OU ENFERRUJADOS!!



221 x 114 x 45 mm

Art. 2036

Jogo de impacto , 23 peças

5/16"

- 4 6-8-10-12 mm
- 4 PH 1-2-3-4
- 4 PZ 1-2-3-4
- 4 T30 - 2xT40 - T45
- 5 4-5-6-8-10 mm

5/16"

3/8"

€ 33,90

~~€ 50,85~~

5/16" 23 PCS

CONJUNTO DE EXTRACTORES DE PARAFUSOS



144 x 143 x 25 mm

Art. 3059

Kit de extractores de parafusos M3-M24, 6 peças

Nos.	<->
1-2-3-4-5-6	M3-M24

6 PCS

€ 9,80

~~€ 15,30~~

PARA PORCAS DANIFICADAS!



164 x 120 x 52 mm

Art. 3058

Conjunto de extractores de porcas danificadas, NiCrMo 10-19 mm, 10 peças

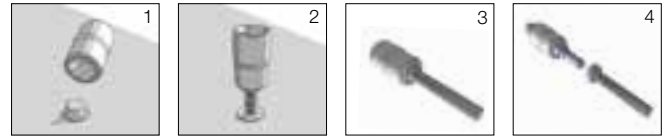

∅
mm

10-11-12-13-14-15-16-17-19

1/2"

NiCrMo

10
PCS

€ 74,90

~~€ 114,00~~



Art. 2212

Conjunto de alicates de freios, 4 peças

€ 35,00

~~€ 55,00~~



CABEÇAS INTERCAMBIÁVEIS

Art. 3291

Alicate de roquete para terminais sem cabeça

€ 43,90

~~€ 69,80~~

Alicates de Pressão

CrMo



Art.	Descrição	Promo €	PVP €
3292-175	Alicate de pressão com maxilas concavas 175 mm	11,50	18,40
3292-250	Alicate de pressão com maxilas concavas 250 mm	12,50	19,00



220 N/mm²

1800 N/mm²

HIGHTECH 3C

**4 EM 1: CORTE,
DESCARNAR, CHAVE E ALICATE**

Art.	Descrição	Promo €	PVP €
4271-165	Alicate Hightech universal 165 mm	14,50	20,50
4271-180	Alicate Hightech universal 180 mm	16,10	22,20
4271-205	Alicate Hightech universal 205 mm	17,80	24,60



1000 V
IEC 60900

HIGHTECH



220 N/mm²

1800 N/mm²

Art. 4211-180

**Alicate Hightech 1000 V
universal 180 mm**

€ 19,90

~~€ 28,50~~



220 N/mm²

1800 N/mm²

HIGHTECH 3C

Art.	Descrição	Promo €	PVP €
4272-145	Alicate de corte diagonal Hightech 145 mm	16,90	23,20
4272-160	Alicate de corte diagonal Hightech 160 mm	17,90	24,60
4272-180	Alicate de corte diagonal Hightech 180 mm	21,10	29,50



220 N/mm²

1800 N/mm²



1000 V
IEC 60900

HIGHTECH

Art. 4212-160

**Alicate de corte diagonal
1000 V Hightech 160 mm**

€ 22,50

~~€ 31,50~~



Art.	Descrição	Promo €	PVP €
4275-170	Alicate de ponta semi-redonda 170 mm	16,50	23,20
4275-205	Alicate de ponta semi-redonda 205 mm	19,90	28,40



Art. 4276-205

**Alicate de ponta
semi-redonda angular
45° 205 mm**

€ 21,50

~~€ 29,40~~

HIGHTECH 3C**Art. 4277-160**

Alicate de pontas planas 160 mm

€15,50~~€ 22,20~~**HIGHTECH 3C****Art. 4278-160**

Alicate de pontas redondas 160 mm

€15,50~~€ 22,20~~**Art. 3292**Conjunto de alicates
ErgoKraft, 4 peças**4** ERGOKRAFT
PCS**€44,90**~~€ 68,40~~**QUALIDADE E CONFIANÇA!**

Art. 3281-180

Art. 3285-200

Art. 3282-160

Art. 2221-250

Art. 3304 ERGOKRAFTFaca com lâminas
trapezoidais

- Cabo ergonómico de 2 componentes
- Sistema de segurança na lâmina e bloqueio do suporte de lâmina
- Inclui 10 lâminas

**€5,95**~~€ 10,05~~**Art. 3312**

X-acto

- Corpo ergonómico para melhor tracção, em ABS
- Guia de lâmina em aço inox
- Carregamento automático da lâmina nova
- Bloqueio de lâmina
- 6 lâminas incluídas

**ERGOKRAFT****€4,55**~~€ 7,20~~



Martelo do tipo Alemão

- Cabeça lacada de preto e faces polidas
- Punho com protecção em aço
- Fabricado em nogueira, pintado e envernizado
- Fixação permanente do cabo e da cabeça por cunhas de aço e cola de segurança epóxida.

Art.	Descrição	Promo €	PVP €
2301	Martelo tipo Alemão 100 g	4,90	7,40
2302	Martelo tipo Alemão 200 g	5,50	8,50
2303	Martelo tipo Alemão 300 g	6,90	11,20
2304	Martelo tipo Alemão 400 g	7,90	12,30
2305	Martelo tipo Alemão 500 g	8,40	13,15
2308	Martelo tipo Alemão 800 g	10,80	16,90
2310	Martelo tipo Alemão 1000 g	12,10	19,20
2315	Martelo tipo Alemão 1500 g	14,90	23,50

Torno paralelo de bancada



FORJADO!

- Base giratória
- Mandíbulas p/ tubos, de aço intercambiáveis
- Bigorna e bico lacado a preto
- Mandíbulas, trilho guia e bigorna afiados e endurecidos.

Art.	Descrição	Promo €	PVP €
2961	100 x 120 x 65 mm, 7.5Kg	88,00	111,00
2962	125 x 140 x 70 mm, 11 Kg	115,00	139,50
2963	150 x 170 x 80 m, 14.5 Kg	136,00	169,50
2964	200 x 200 x 90 mm, 20.5 Kg	185,00	228,00



Martelo do tipo Alemão, peça única

- Indestrutível
- Punho ergonómico em bi-matéria

Art.	Descrição	Promo €	PVP €
2318	Martelo tipo alemão, peça única 300 g	13,70	23,80
2319	Martelo tipo alemão, peça única 500 g	16,60	28,80

Art. 2336

Maço em nylon com cabeças rígidas intercambiáveis (nylon e poliuretano)

- Pega em madeira lacada
- Bloqueio da cabeça com cunha em aço e resina epóxida

€ 13,50

~~€ 21,95~~



360 gr.

Art. 3374

Jogo de punções, escopro e buril, 17 peças

- Formato redondo com ponta temperada
- Ø3 x 160 mm, Ø4 x 185 mm, Ø5 x 200 mm, Ø6 x 210 mm, Ø8 x 225 mm
- Possibilidade de pendurar o suporte 250 x 230 x 58 mm



€ 49,50

~~€ 59,50~~

17 PCS

Art. 3359

- Punção automático**
 - Sistema de molas
 - Ponta intercálvel

€ 6,90

~~€ 10,05~~



Art. 2251

- Tesoura de electricista**

€ 6,50

~~€ 10,20~~



Comprimento: 142 mm

Art. 2972

Paquimetro digital

- Com parafuso de ajuste
- Leitura em mm/pol
- Display LCD 5 dígitos,
- Para medições externas, internas e de profundidade
- Em estojo de plástico robusto

2.09 digital inox



€ 26,90

~~€ 39,85~~

DIGITAL!

Fita métrica

- Caixa em ABS resistente aos choques com protecção de borracha anti-derrapante.
- Fita em aço revestida em nylon, graduação impressa em mm dos dois lados.
- Botão grande de bloqueio da fita.
- Gancho com dois imans.
- Clip de cinto removível.
- Classe de precisão II



Art.	Comprim.	Altura	Dimensões	Promo €	PVP €
4704-0319	3 mts	19mm	68 x 63 x 29mm	4,25	7,80
4704-0525	5 mts	25mm	74 x 67 x 38mm	5,70	10,30
4704-0825	8 mts	25mm	84 x 75 x 36mm	7,35	13,40



DIN 7261

- Art. 4320-1
- Art. 4320-2
- Art. 4320-3
- Art. 4320-4
- Art. 4320-5



T12 5 PCS

Art. 4320

- Conjunto de limas, meia murça, com cabo bi-matéria**

€ 24,90

~~€ 39,50~~



Art. 3305

- Serrote com folha de serra HSS bimetálica, punho de 2 componentes e sistema rápido de troca de lâmina**

€ 14,10

~~€ 23,10~~

Art. 32085

Lampada LED SLIMFLEX,
recarregável

Níveis de brilho ajustáveis,
com imã na base e costas.
Quando dobrada funciona
como lanterna de bolso.

Autonomia 3 - 8 h
Tempo de carga 3 h
Bateria Li-Ion 3,7 V / 2000 mAh
25/105 Lux (1 m)
70/400 lumen
5700 Kelvin
IP54
IK07
302 x 44 x 34 mm
0,35 kg

**COM LED
NA PEGA!**

€ 47,00

~~€ 65,00~~



Art. 32071

Lampada LED portatil
IN.VIEW 250, recarregável

LED COB 3 W e também
LED 1 W LED SMD colocado
no topo, poderoso imã
inserido na base, gancho no
topo giratório, dobrável e
ajustável 180°.

Autonomia 3-10 h
Tempo de carga 3h
Bateria Li-Ion 3,7 V / 2600 mAh
115/165 Lux (1 m)
70/250 lumen
6000 Kelvin
IP20
IK07
290 mm, Ø 40 mm
0,5 kg

€ 39,50

~~€ 59,50~~

**DOBRÁVEL,
COM LED COB!**



Art. 32075

Lampada LED portatil
COMPACT 110, recarregável

Com LED SMD, ângulo
de iluminação 30°, imã
na traseira e gancho
incorporado.

Autonomia 4 - 4,5 h
Tempo de carga 3 h
Bateria Li-Ion 3,7 V / 1500 mAh 870
Lux (0,6 m)
110 lumen
6500 Kelvin
IP65
IK07
210 x 60 x 40 mm
0,16 kg

RECARREGAVEL!

€ 34,00

~~€ 48,00~~



Art. 32032

Lampada LED portatil
COMPACT 350,
recarregavel

1 LED adicional no topo,
com 2 imãs incorporados
na traseira e base, cabeça
inclinável e gancho
rotativo.

Autonomia 3 h
Tempo de carga 3,5 h
Bateria Li-Ion 3,7 V / 2000 mAh
100/350 lumen
190 x 56 x 29 mm
0,26 kg
Fornecido com base de carga 230 V
art. 32070AL



Art. 32032LS
Base de carga para
32032, 32033

€ 9,50

~~€ 13,15~~

€ 36,00

~~€ 49,50~~



Art. 32080

Lampada de trabalho LED T5000

47 watt
120 SMD LED
Classe energética A++ 1860 Lux (1 m)
5000 lumen
6000 Kelvin
IP54
5 m de cabo
230 V
2 tomadas (tipo F)
363 x 278 x 98 mm
2,7 kg

€108,00

~~€125,00~~



Art. 32080C

Lampada de trabalho LED T5000 com tripé telescópico removível

Estrutura metálica de 3 pernas para maior estabilidade. rotação a 360°

COM TRIPÉ

€138,00

~~€148,00~~



IDEAL PARA ILUMINAR ESPAÇOS AMPLOS!

Foco industrial em alumínio 35w COB-LED

- Art. 32025 - Bateria 11.1V - 3,5 horas
- Art. 32026 - 240V 50/60 Hz - 5mts cabo
- COB-LED com angulo 120°
- Sólido e leve
- Grande longevidade (50000 h)
- IP67: Ideal para uso externo

€99,00

~~€128,00~~

Art. 32025



€103,00

~~€158,00~~

Art. 32026



Art. 32035

Lanterna tipo caneta para controlo de cor

- 1W OSRAM HIGH CRI COB LED
- Intensidade de 80 lumens (2h)
- Intensidade de 20 lumens (6h)
- IPX4, Iluminação até 70mts
- 138mm x Ø16mm



€16,80

~~€26,20~~

Art. 32025-1

Punho para 32025/26

€6,30

~~€7,80~~



Art. 32025-2

Suporte para 32025/26

€8,75

~~€11,00~~



COM FUNÇÃO COLOR CONTROL

Art. 32033

Lampada portátil recarregável
Color Control
LED COBHIGH CRI 5 W

Autonomia 3 - 3,5 h
Tempo de carga 4 - 4,5 h
Bateria Li-Ion 3,7 V / 2600 mAh
180 - 380 lumen
IP65
IK07
190 x 56 x 36 mm
0,6 kg



Art. 32032LS
Base de carga para
32032, 32033



€59,50

~~€78,00~~

€9,50

~~€13,15~~

COM GANCHOS PARA CAPOT



Art. 32073

Lampada de trabalho LED BONNET 1200

Para iluminação de motor e internos
do motor, com ganchos telescópicos
removíveis e extensíveis de 1100 a
1700mm, lâmpada removível.

LED SMD 12 W
Standard energético A++
1200 lumen
IP54
240 V
5 m de cabo
2,13 kg

€79,50

~~€99,00~~

Art. 32078-03

Lampada de trabalho LED W1000
com trilho de guia. Posicionamento da
lâmpada como desejado com fixação por
parafuso. Gancho telescópico removível
com extensão de 1200 a 1900mm. Com
apoio 32078-02 pode ser montado nou-
tros formatos de suporte.

1,95 kg

Fornecido com:

Lampada de trabalho LED art. 32078

Guia telescópica art. 32078-01

Suporte art. 32078-02

Carregador de baterias 230 V art. 32070AL

Adaptador auto 12 / 24 V art. 32070DL



€125,00



Art. 32074

Lampada portátil LED
TUBE 420
54 LED SMD, ângulo
de iluminação 120°,
corpo em borracha.

420 lumen
IP54
IK07
5 m de cabo
Classe energética A++
220-240V ~ 50/60 Hz
480 mm, Ø 50 mm
0,65 kg

€17,80

~~€25,00~~



Art. 32078

Lampada de chão 10W COB LED W1000,
recarregável

€108,00

Art. 32043

3 níveis de brilho + função flash
 Suporte magnético e indicador de carga
 Autonomia 5 - 25 h
 1800 Lux (1 m) LED CREE 3W
 75 - 320 lumen - IPX5
 141 mm, Ø 36 mm
 0,18 kg
 Acessorios:
 Bateria AA (3x) art. 32012
 Bateria recarregável Li-Ion art. 32048

**€ 47,00**~~€ 76,80~~**Art. 32044**

2 níveis de brilho + função flash
 e indicador de carga
 Autonomia 3,5 - 12 h
 3200 Lux (1 m) LED CREE 3W
 150 - 320 lumen
 IPX6
 143 mm, Ø 36 mm, Ø 30 mm
 0,15 kg
 Acessorios
 Bateria AAA (3x) art. 32013
 Bateria recarregável Li-Ion art. 32047

**€ 44,50**~~€ 69,80~~**Art. 32042**

2 níveis de brilho, função flash
 Alcance até 250m e indicador de carga
 Autonomia 3,5 - 12 h, 2000 Lux (1 m)
 150 - 320 lumen, IPX5, LED CREE 3W
 130 mm, Ø 27 mm
 0,13 kg
 Acessórios
 Baterias AAA (3x) art. 32013
 Bateria recarregável Li-Ion art. 32047

**€ 44,50**~~€ 69,80~~**COM SUPORTE P/
GUIADOR DE BICICLETA****Art. 32045**

3 níveis de brilho
 Pescoço de cisne
 Suporte magnético sólido e indicador
 de carga
 Autonomia 5 - 25 h
 440 Lux (0.5 m) LED CREE 3W
 75 - 320 lumen
 IPX6
 450 mm, Ø 36 mm
 0,33 kg
 Acessorios
 Bateria AA (3x) art. 32012
 Bateria recarregável Li-Ion art. 32048

**€ 54,60**~~€ 86,80~~**Art. 32046**

3 níveis de brilho
 Pescoço de cisne
 Suporte magnético sólido
 Iman removível na cabeça lâmpada
 Indicador de carga
 Autonomia 5 - 25 h
 480 Lux (0.5 m)
 75 - 320 lumen
 IPX6
 459 mm, Ø 18 mm
 0,29 kg
 Acessorios
 Bateria AA (3x) art. 32012
 Bateria recarregável Li-Ion art. 32048

**€ 51,20**~~€ 79,80~~**DIRECCIONAVEL**

Art. 32061

Lanterna de cabeça de alta potência
Em alumínio, com LED CREE 3 watt,

Com função de zoom, dimmer e intermitente, ângulo de iluminação regulável. Com leds vermelhos na traseira.

Autonomia 4 - 12 h
160 lumen
IP44
45 mm, Ø 40 mm
0,13 kg



€ 17,50

~~€ 24,65~~

Art. 32058, 32058B, 32058G

Lanterna tipo caneta PENLIGHT 140, recarregável

Com 6 +1 LED SMD, clip de bolso e imã.
Disponível em 3 cores: Cinza (32058), Azul (32058B) e Verde (32058G)

80 - 540 Lux (1m)
100 - 140 lumen
IK07
169 x 29 x 21 mm
0.05 kg

**3 CORES
DISPONÍVEIS**



Art. 32058

Art. 32058B

Art. 32058G

€ 17,50

~~€ 24,50~~

Carregadores inteligentes e profissionais

- Pode ser utilizado em veículos com Start/Stop, graças a opção Boost (Art. 31313 / 31314)
- Diagnostico do estado da bateria
- Possibilidade de carga total através de impulsos
- Protecção contra troca de polaridade, curto-circuito e sem faíscas

- Protege a electrónica do veículo
- Programa automatico de desulfatação
- Modo "Inverno" para carga optimizada em climas frios
- Utilização prolongada graças a microprocessador
- Leitura das várias fases de carga através de indicador LED
- Fornecido com pinças, tomada de isqueiro e cabo para bateria.



Art. 31311

± 153.5 x 59 x 37.5 mm



Art. 31312

± 175 x 65 x 43.5 mm



Art. 31313

± 206 x 88.5 x 52 mm



Art. 31314

± 305 x 135 x 70 mm



Voltagem da bateria	6-12 V	12 V	12-24 V	12-24 V
Consumo de energia	30 W	60 W	135 W	460 W
Voltagem efectiva	6 V: 2.2 - 14 Ah 12 V: 2.2 - 40 Ah	12 V: 1.2 - 120Ah	12 V: 14 - 225 Ah 24 V: 14 - 110 Ah	12 V: 50 - 450 Ah 24 V: 25 - 230 Ah
Carga por impulsos	■	■	■	■
Corrente de carga	max. 1.1 A	max. 3.8 A	max. 7.0 A	max. 25 A
Corrente de entrada	220 - 240 V / 0.35 A	220 - 240 V / 0.6 A	220 - 240 V / 1.2 A	220 - 240 V / 4 A
Adequado para	SLA, AGM, WET, GEL, MF, Ca-Ca	SLA, AGM, WET, GEL, MF, Ca-Ca	SLA, AGM, WET, GEL, MF, Ca-Ca	SLA, AGM, WET, GEL, MF, Ca-Ca
	€ 42,50	€ 59,50	€ 99,00	€ 238,00
	€ 51,15	€ 71,70	€ 123,05	€ 287,35

Boosters de emergência

- Corpo antichoque ABS
- Pinças de latão completamente isoladas
- Cabos extra longos
- Baterias de chumbo.
- Ligação de isqueiro incluído em 31306 / 31307: protecção de sobrecarga com sinal acustico e visual

FUNCIONA MESMO COM BATERIA DO VEICULO TOTALMENTE DESCARREGADA



Art. 31305

⚖ 9.8 kg

↔ 350 × 170 × 330 mm

Art. 31306

⚖ 20 kg

↔ 345 × 240 × 330 mm

Art. 31307

⚖ 22.3 kg

↔ 345 × 300 × 455 mm

Tipologia	Portatil	Portatil	Com trolley
Voltagem	12 V	12-24 V	12-24 V
Amperagem de arranque	2500 A	5000 / 2500 A	5000 / 2500 A
Amperagem continua	950 A	1900 A	1900 A
Capacidade da bateria	12 V 24 Ah	2x 12 V 24 Ah	2x 12 V 24 Ah
Alimentação de carga	230 V 50 Hz	230 V 50 Hz	230 V 50 Hz
Capacidade de carga	12 V 1,5 Ah	12 V 4 Ah	12 V 4 Ah
Diâmetro dos cabos	25 mm ²	50 mm ²	50 mm ²
Comprimento dos cabos	160 cm	228 cm	200 cm
	€ 258,00	€ 592,00	€ 698,00
	€ 298,00	€ 698,00	€ 798,00

Art. 31317 Booster de emergência de supercondensador 12V GigaStart

⚖ 9.5 kg

↔ 345 × 240 × 330 mm

Amperagem de arranque	9000 A
Amperagem continua	1800 A
Capacidade da bateria	500 Farad / 12 V
Tempo de carga	30 sec. - 10 min.
Diâmetro dos cabos	50 mm ²
Comprimento dos cabos	160 cm



GIGASTART

€ 792,00



~~€ 888,00~~

GigaStart não é um booster convencional. Os supercondensadores de alta qualidade garantem um uso imediato, mesmo após longos períodos de inactividade



**ARRANQUES INFINITOS
GRAÇAS AOS CONDENSADORES**

12 V 1800 CA / 9000 A / 500 F

Art. 31140-T10 Analisador gráfico com impressora

- Adequado para baterias de 12V (chumbo, liquidas, gel, MF, VRLA, Calcio e AGM)
- Analisa a condição da bateria e a resistência interna
- Verifica a capacidade de arranque, condição de carga do alternador e condição do retorno do circuito eléctrico
- Protecção de inversão de polaridade
- Display grafico com instruções passo a passo
- Memoriza até 70 testes
- Sem necessidade de manutenção

€ 315,00





max. 120 kg ABS



€ 51,00

~~€ 66,75~~

↕ 1010 x 480 x 115 mm

Art. 3991

Estrado de mecânico em ABS

- Construído em ABS sólido, equipado com pega de transporte
- Com forma ergonômica para fácil adaptação de todas as fisionomias, permitindo uma fácil movimentação dos braços e ombros
- Equipado com apoio de cabeça acolchoado
- Porta-ferramentas moldados na estrutura, em ambos os lados
- 6 rodas em giratórias independentes em borracha

Art. 3989

Estrado/banco de mecânico 2 em 1.

- Estrutura em alumínio
- Assento revestido a borracha.



2 in 1



Max. 150 kg



↕ 1020 x 455 x 150 mm

↕ 540 x 455 x 500 mm

€ 71,50

~~€ 90,40~~

Art. 3984

Banco de mecânico

- Com 5 rodas giratórias
- Assento confortável
- Base para suporte de ferramenta

ALTURA AJUSTÁVEL



↕ 450 - 570 mm, Ø 450 mm



max. 570 mm min. 450 mm

Max. 135 kg

€ 76,00

~~€ 99,90~~

Art. 380005

Conjunto de chaves de caixa de impacto 1/2", 16 peças

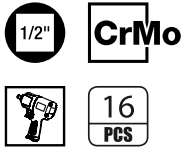

270 x 185 x 58 mm

€ 58,00

~~€ 88,20~~

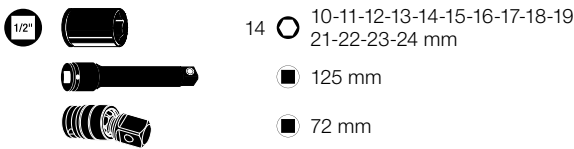

Art. 381099

Serie MAGALU chaves de caixa longas, qualidade impacto 1/2", 3 peças

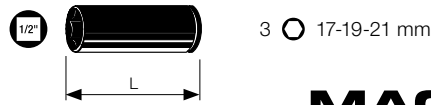

MAGALU

€ 23,00

~~€ 34,90~~

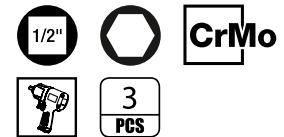

Art. 32103

Chave de impacto sem fios 1/2" 18 V

- Binário: 850 Nm máx.
- Design compacto, bem balanceado e ergonómico
- 0-2000 RPM/min / 0-3000 IMP para uma utilização mais rápida
- regulação de binário com 6 níveis e indicação digital



€ 559,00

~~€ 610,00~~

Art. 32104

Chave de impacto sem fios 1/2" 18 V de alta potência

- Binário: 1500 Nm
- Design robusto e ergonómico
- 0-1700 RPM/min / 0-2000 IMP para uma utilização mais rápida
- regulação de binário com 6 níveis e indicação digital



€ 659,00

~~€ 710,00~~

1/2"	850	640	400	Embraiagem digital 5+ Max.	0-2000	0-3000	1.93

1/2"	1500	1060	680	Embraiagem digital 5+ Max.	0-1700	0-2000	3.26

BINÁRIO MÁX. 1500 NM!

Art. 3084

Conjunto de chaves de impacto Torx 1/2", 12 pcs

€ 68,00

~~€ 100,50~~



CrMo



12 PCS

↕ 210 x 145 x 50 mm



12 T10-T15-T20-T25-T27-T30
T40-T45-T50-T55-T60-T70

Art. 3086

Conjunto de chaves sextavadas de impacto 1/2", 12 pcs



↕ 210 x 145 x 50 mm

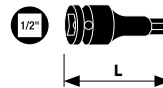

12 3-4-5-6-7-8-9-10
12-14-16-17 mm

€ 78,00

~~€ 110,80~~



CrMo



12 PCS

Art. 4900-74K

Caixa de ferramenta para substituição de sensores de pressão dos pneus TPMS



COMPLETO

↕ 421 x 200 x 68 mm

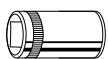

11-12 mm

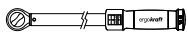
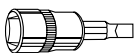

Art. 3231

2.5-12 Nm / 20-105 Lb.in

€ 159,00

~~€ 213,60~~



15 PCS

Art. 3089

Conjunto de chaves de impacto RIBE 1/2"



↕ 210 x 145 x 50 mm

RM4-RM5-RM6-RM7-RM8-RM9-RM10-RM12-RM13-RM14

€ 72,00

~~€ 90,40~~



CrMo



10 PCS

Art. 31004

Pistola de ar digital profissional

- ecrã grande e escala bar / psi / kpa e kgf.
- Construção anti-choque.
- 3 em 1: medição de pressão, inflação e deflacao.
- Precisão: +/- 1 %.

€ 58,90

~~€ 90,40~~



Art. 505.002.001

Pistola de ar analógica profissional

- Escala em bar.
- Construção robusta.

€ 109,50

~~€ 138,40~~



Art. 31008

Ferramenta de emergência e medidor de pressão de pneus digital



PORTATIL E MULTIUSO!!!

€ 20,80

~~€ 33,90~~



Chave metálica de cinta para filtros de óleo

Art.	Descrição	Promo €	PVP €
30617	65-110 mm	6,50	8,40
30618	110-155 mm	7,20	9,75



Art. 2585-12

Chave de cruzeta para rodas 17 x 19 x 22 mm x 1/2"

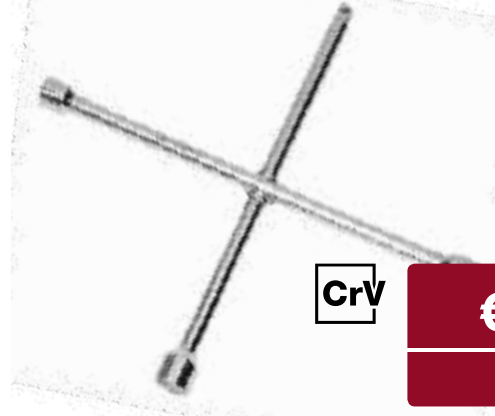

CrV

€ 12,90

~~€ 20,35~~

Art. 2951

Bandeja magnética em aço inox, rectangular



240 x 140 x 40 mm

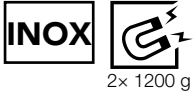

€ 10,50

€ 16,25

Bandejas magnéticas em ABS



Art.	Cor	Promo €
2949-1	Vermelha	9,50
2949-2	Cinza	9,50
2949-3	Verde	9,50

Art. 30624-26

Conjunto de 3 aparadeiras de óleo com bico de drenagem



Adequado para a maioria dos solventes (T<60°C) ácidos, alcalinos, álcool, óleos de gasolina, construção em HDPE anti-choque.

€ 72,50

€ 103,30



Art. 30620

Conjunto de chaves de taça para filtro de óleo, 30 peças - 65 a 100mm



410 x 265 x 80 mm

Art.	Dim.	Aplicação	Art.	Dim.	Aplicação
30620-0504	+ 50 mm (2 3/8") + 53 mm + 1 peça	Para Óleo Hidráulico (HM), Vela, Filtro Rotativo (Diferencial Torção, Motor etc.)	30620-0510	+ 50 mm (2 3/8") + 53 mm + 1 peça	Hastilha, Filtro Rotativo (Motor, Filtro Rotacional, Motor, Motor, Motor, Motor etc.)
30620-0507	+ 55 mm (2 1/4") (2 1/4") + 58 mm + 2 peças	Filtro de óleo de Carburador (Vela, Motor, Motor, Motor, Motor, Motor, Motor etc.)	30620-0512	+ 55 mm (2 1/4") (2 1/4") + 58 mm + 1 peça	Vela, Filtro Rotativo (Vela, Motor, Motor, Motor, Motor, Motor etc.)
30620-0508	+ 58 mm (2 3/8") + 61 mm + 1 peça	Hastilha, Motor, Filtro Rotativo (Vela, Motor, Motor, Motor, Motor, Motor etc.)	30620-0515	+ 58 mm (2 3/8") + 61 mm + 1 peça	Filtro Rotativo (Motor, Motor, Motor, Motor etc.)
30620-0514	+ 65 mm (2 5/8") + 68 mm + 1 peça	Tronco (Motor etc.)	30620-0518	+ 65 mm (2 5/8") + 68 mm + 1 peça	Carburador (Motor, Motor, Motor, Motor, Motor, Motor, Motor, Motor etc.)
30620-0516	+ 65 mm (2 5/8") (2 5/8") + 68 mm + 1 peça	Óleo, Filtro (Vela, Motor, Motor, Motor, Motor, Motor, Motor, Motor etc.)	30620-0519	+ 65 mm (2 5/8") (2 5/8") + 68 mm + 1 peça	Motor, Motor, Motor, Motor, Motor, Motor, Motor, Motor etc.
30620-0517	+ 67 mm (2 5/8") (2 5/8") + 70 mm + 2 peças	Vela, Vela, Carburador (Motor, Motor, Motor, Motor, Motor, Motor, Motor, Motor etc.)	30620-0520	+ 67 mm (2 5/8") (2 5/8") + 70 mm + 1 peça	Filtro Rotativo (Motor, Motor, Motor, Motor, Motor, Motor, Motor, Motor etc.)
30620-0518	+ 70 mm (2 3/4") + 73 mm + 1 peça	Carburador (Motor, Motor, Motor, Motor, Motor, Motor, Motor, Motor etc.)			
30620-0520	+ 70 mm (2 3/4") + 73 mm + 1 peça	Motor, Motor, Motor, Motor, Motor, Motor, Motor, Motor etc.			

€ 52,00

€ 81,65

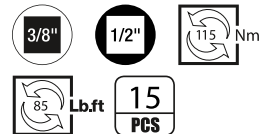



190 x 105 x 40 mm

Art. 30641

Kit de reparação de roscas métricas

	PCS	Ø x  mm
		M16 x 1.25
30641-1	5x	M16 x 1.25 x 11.2 mm
30641-2	5x	M16 x 1.25 x 17.5 mm
30641-3	5x	M16 x 1.25 x 17.5 mm
30641-4	1x	M16 x 1.25 x 70 mm

€ 43,20

~~€ 69,30~~



305 x 235 x 55 mm

€ 105,00



~~€ 163,80~~

Art. 30627

Kit reparação de bujão p/ cárter de óleo, 28 pcs

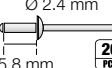
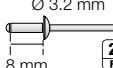
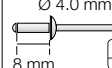
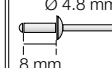

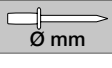
Ø 2.4 mm	Ø 3.2 mm	Ø 4.0 mm	Ø 4.8 mm
 5.8 mm	 8 mm	 8 mm	 8 mm
20 PCS	20 PCS	20 PCS	20 PCS

Art.	 Ø mm	 pcs.
2224	2.4-3.2-4.0-4.8	20

Art. 2224
Conjunto de alicate de rebites e rebites

€ 28,00

~~€ 45,00~~

Art. 31105

Jogo testa pressão de travões



Escala:
0-3000 psi
0-200 kg/cm2

595 x 265 x 60 mm

€ 192,85

~~€ 333,80~~



Art. 30651

Ferramenta universal de bloqueio para arvore de cames dupla



↕ 345 x 150 x 90 mm

€ 51,75

~~€ 79,10~~









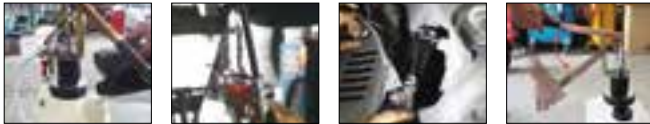

Art. 30653

Dispensador de óleo com válvula de retenção

↕ 255 x 155 x 45 mm

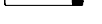

		
AT-101		Ford (1/8" NPT)
AT-102		Universal
AT-103		Audi, VW
AT-104		Audi, Porsche, VW
AT-105		Audi, Mini Cooper (M10 x 1.0 mm), VW
AT-106		Altis 2010, Benz 722.9 (M12 x 1.5 mm)
AT-107		Audi, DSG (M24 x 1.5 mm), VW
AT-108		Audi, CVT (M22 x 1.5 mm), VW

€ 278,00

~~€ 398,00~~

7.5 L

8 PCS

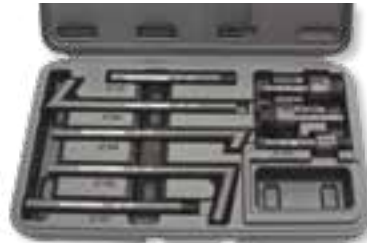

Art. 31135

Termometro infravermelhos

- Leitura de temperatura: -38°C a 520° C
- Precisão +/- 2°C
- Medição de 0,1 °C



€ 42,00

~~€ 69,50~~

Art. 30808

Conjunto de ferramentas para desmontar plásticos e forros de porta auto.

- Fabricado em fibra reforçada
- Para desmontagem das guarnições, forros da porta, molas plásticas, espelhos, etc



11
PCS

€ 48,50

~~€ 69,30~~

PARA UMA DESMONTAGEM RÁPIDA

Art. 30809

Conjunto de alavancas em aço para desmontagem de peças auto, 5 peças

inox 5
PCS

€ 52,00

~~€ 81,65~~

AÇO INOXIDÁVEL



Art. 3190

Estojo com conjunto magnético profissional



€ 56,90

~~€ 91,90~~

Art. 31031

Pistola de soprar extensível



€ 13,50

~~€ 19,30~~

AIR	AIR	AIR	max. bar	dBA
1/4"	144	1/4" BSP	14	<73

Art. 38003

Protecção de joelhos e assento com iluminação LED

€ 28,00

~~€ 39,50~~





Art. 31126

Verificador OBD-II

- Instrumento de diagnóstico Auto
- Para todos os veículos fabricados após 1996 com porta OBD-II.
- Permite a leitura e cancelamento de códigos de erro
- Suporta protocolos CAN, VPW, PMW, ISO e KWP 2000



€ 59,80

~~€ 89,50~~

Art. 31129

Tester para bateria e alternador

Art.		
31129	Fraço	●
	Suficiente	● ●
	Bom	● ● ●
	Fraço	● ● ● ●
	Normal	● ● ● ● ●
	Elevado	● ● ● ● ● ●

€ 7,50

~~€ 10,15~~



126 x 78 x 28 mm

Art. 31130

Multímetro digital

- Com mais de 10 funções
- Display iluminado
- Leitura de temperatura -55°C ~ 1000°C
- Função Hold



178 x 85 x 40 mm

CAT. II 1000 V CAT. III 600 V

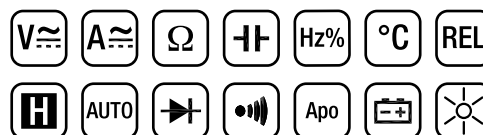

€ 65,00

~~€ 89,50~~

Revendedor Autorizado

TECNIVERCA

Filial:
Rua. Eng. Ferreira Dias
Nº444 - Arm. 4
Zona Industrial Porto -
Ramalde
4100-246 Porto

Promoção válida de 15 de Outubro de 2018 até 15 de Abril de 2019
Sujeito a alterações de modelos, preços e disponibilidade de stock.
Imagens ilustrativas, sujeito a alteração de cores ou formatos.
A Tecniverca não se responsabiliza por erros tipográficos.
I.V.A. Não Incluído

www.tecniverca.pt
tecniverca@tecniverca.pt

Sede:
Estr. Municipal 1022
N.º 339 - Pinhal da Areia
2860-302 Moita
Tel: 00351 219 584 273
Fax: 00351 219 577 133